

Description

The FERD30SM100DJF is based on a proprietary technology that achieves the best in class V_F/I_R trade-off for a given silicon surface.

This 100 V rectifier has been optimized for use in confined applications where both efficiency and thermal performance are key.

Table 1. Device summary

Symbol	Value
$I_{F(AV)}$	30 A
V_{RRM}	100 V
$T_j(max)$	+175 °C
$V_F(typ)$	0.395 V

Features

- ST proprietary process
- Reduce leakage current
- Low forward voltage drop
- High frequency operation
- ECOPACK®2 compliant component

TM: PowerFLAT is a trademark of STMicroelectronics

1 Characteristics

Table 2. Absolute ratings (limiting values, at 25 °C, unless otherwise specified, anode terminals short-circuited)

Symbol	Parameter	Value	Unit
V _{RRM}	Repetitive peak reverse voltage	100	V
I _{F(RMS)}	Forward rms current	45	A
I _{F(AV)}	Average forward current, δ = 0.5	T _c = 100 °C	A
I _{F(SM)}	Surge non repetitive forward current	t _p = 10 ms sinusoidal	A
T _{stg}	Storage temperature range	-65 to + 175	°C
T _j ⁽¹⁾	Maximum operating junction temperature	175	°C

1. $\frac{dP_{tot}}{dT_j} < \frac{1}{R_{th(j-a)}}$ condition to avoid thermal runaway for a diode on its own heatsink

Table 3. Thermal resistance

Symbol	Parameter	Value (max)	Unit
R _{th(j-c)}	Junction to case	2.6	°C/W

Table 4. Static electrical characteristics (anode terminals short-circuited)

Symbol	Parameter	Test conditions	Min.	Typ.	Max.	Unit
I _R ⁽¹⁾	Reverse leakage current	T _j = 25 °C	-	-	150	μA
		T _j = 125 °C				
		T _j = 125 °C	-	8	16	mA
V _F ⁽²⁾	Forward voltage drop	T _j = 25 °C	-	-	0.48	
		T _j = 125 °C				I _F = 5 A
		T _j = 25 °C	-	-	0.595	
		T _j = 125 °C				I _F = 10A
		T _j = 25 °C	-	-	0.97	
		T _j = 125 °C				I _F = 30 A
		-	0.665	0.735		

1. Pulse test: t_p = 5 ms, δ < 2%

2. Pulse test: t_p = 380 μs, δ < 2%

To evaluate the conduction losses use the following equation:

$$P = 0.562 \times I_{F(AV)} + 0.0057 I_{F(RMS)}^2$$

Figure 1. Average forward power dissipation versus average forward current

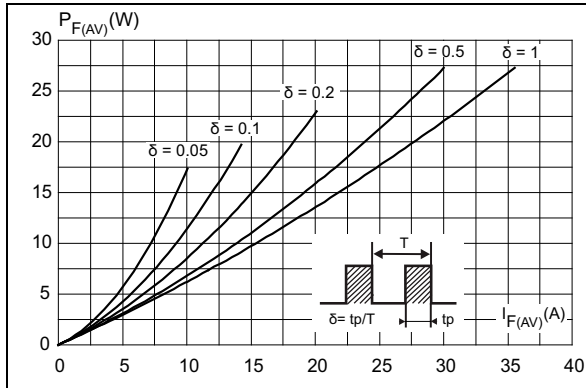

Figure 2. Average forward current versus ambient temperature ($\delta = 0.5$)

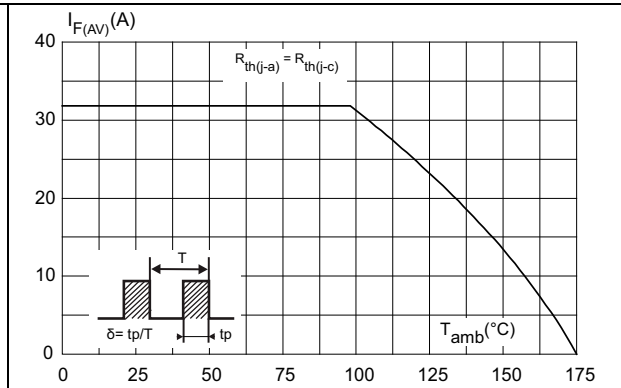

Figure 3. Relative variation of thermal impedance junction to case versus pulse duration

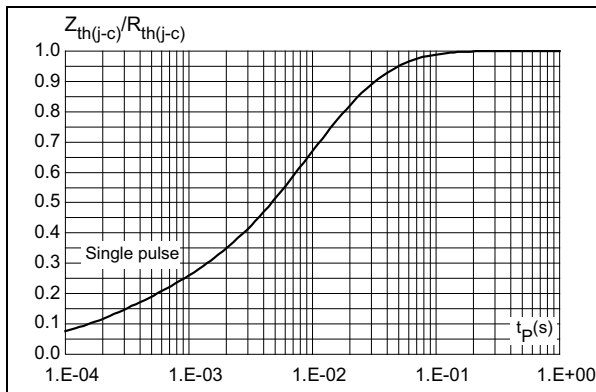

Figure 4. Reverse leakage current versus reverse voltage applied (typical values)

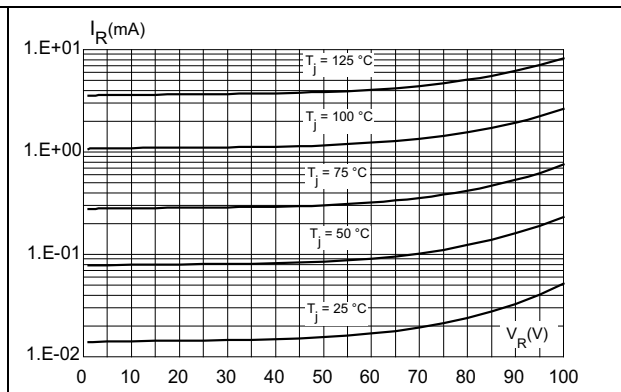

Figure 5. Junction capacitance versus reverse voltage applied (typical values)

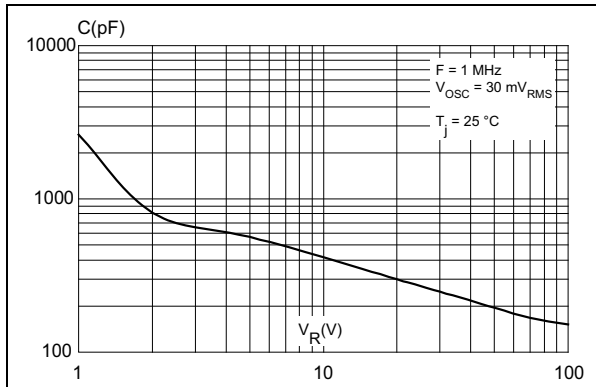

Figure 6. Forward voltage drop versus forward current (typical values)

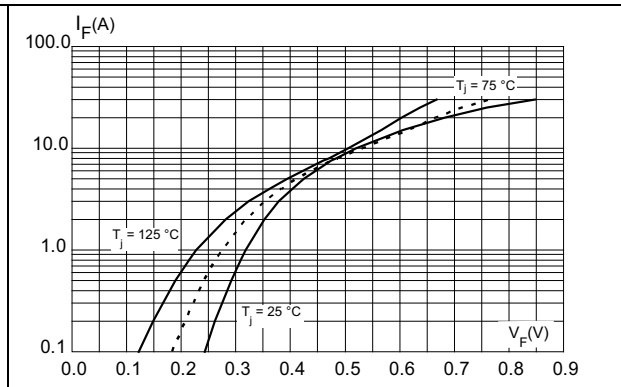
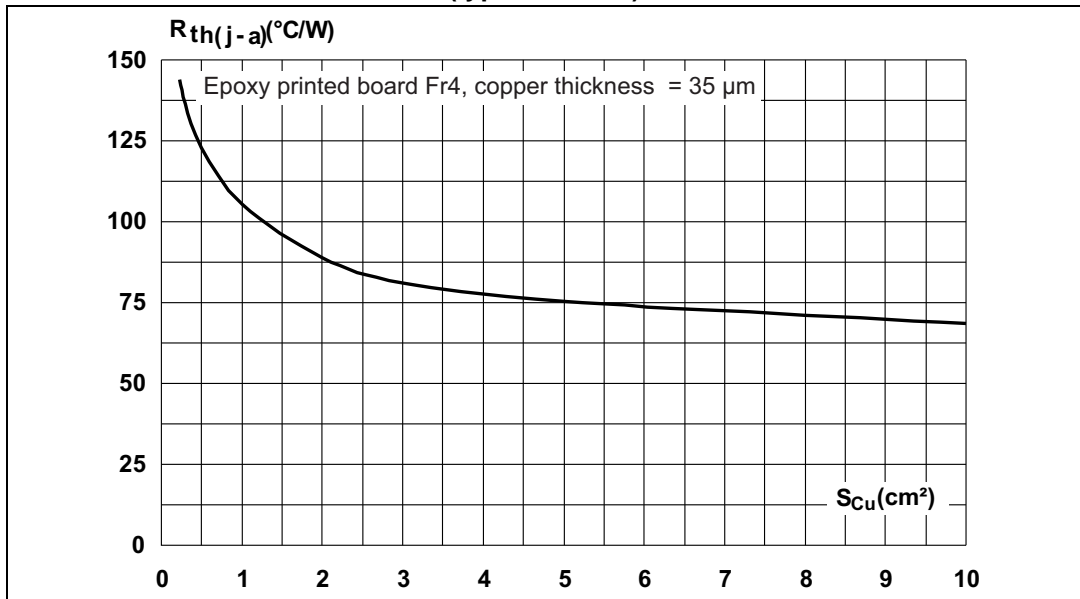

Figure 7. Thermal resistance junction to ambient versus copper surface under tab (typical values)



2 Package information

- Epoxy meets UL94, V0
- Cooling method: by conduction (C)

In order to meet environmental requirements, ST offers these devices in different grades of ECOPACK® packages, depending on their level of environmental compliance. ECOPACK® specifications, grade definitions and product status are available at: www.st.com. ECOPACK® is an ST trademark.

Figure 8. PowerFLAT-8L dimensions (definitions)

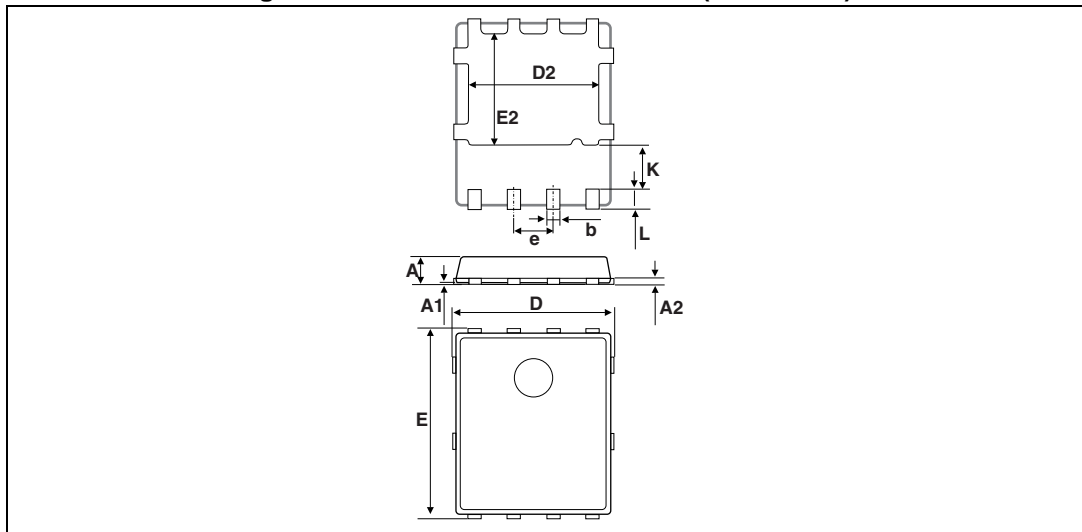
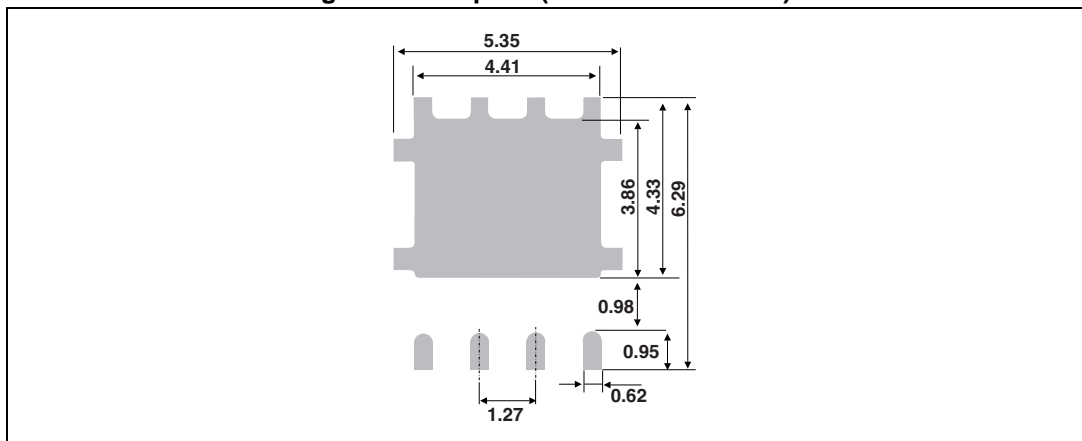

Table 5. PowerFLAT-8L dimensions (values)

Ref.	Dimensions					
	Millimeters			Inches		
	Min.	Typ.	Max.	Min.	Typ.	Max.
A	0.80		1.00	0.031		0.039
A1	0.02		0.05	0.001		0.002
A2		0.25			0.010	
b	0.30		0.50	0.012		0.020
D		5.20			0.205	
D2	4.11		4.31	0.162		0.170
e		1.27			0.050	
E		6.15			0.242	
E2	3.50		3.70	0.138		0.146
L	0.50		0.80	0.020		0.031
K	1.275		1.575	0.050		0.062

Figure 9. Footprint (dimensions in mm)



3 Ordering information

Table 6. Ordering information

Order code	Marking	Package	Weight	Base qty	Delivery mode
FERD30SM100DJF	F30SM 100	PowerFLAT 5x6	95 mg	3000	Tape and reel

4 Revision history

Table 7. Document revision history

Date	Revision	Changes
09-Jan-2015	1	Initial release.

IMPORTANT NOTICE – PLEASE READ CAREFULLY

STMicroelectronics NV and its subsidiaries ("ST") reserve the right to make changes, corrections, enhancements, modifications, and improvements to ST products and/or to this document at any time without notice. Purchasers should obtain the latest relevant information on ST products before placing orders. ST products are sold pursuant to ST's terms and conditions of sale in place at the time of order acknowledgement.

Purchasers are solely responsible for the choice, selection, and use of ST products and ST assumes no liability for application assistance or the design of Purchasers' products.

No license, express or implied, to any intellectual property right is granted by ST herein.

Resale of ST products with provisions different from the information set forth herein shall void any warranty granted by ST for such product.

ST and the ST logo are trademarks of ST. All other product or service names are the property of their respective owners.

Information in this document supersedes and replaces information previously supplied in any prior versions of this document.

© 2015 STMicroelectronics – All rights reserved